

MEDENUS



Gas Pressure Regulation



Gas Pressure Regulator

RSP 254 / RSP 255

Regulator

R 70-10 / R 70-20 / R 70-100

Actuator

AS 254 / AS 255

Product information



EN

Table of Contents

Application, Characteristics, Technical Data	4
Application	4
Characteristics	4
Type of model / Options	4
Technical data	5
Structure and function	6
Installation examples	7
Sectional view	8
(Valve) flow coefficient K_G^* and diaphragm assemblies	10
SSV setpoint spring table - control device	10
Regulator setpoint spring table	12
Dimensions, Connection, and Weight	13
Dimensional drawing	13
Dimensions and weight	15
Connection example	17
Gas pressure regulator RSP 254 with integrated SSV indirect-acting	18
Gas pressure regulator RSP 254 with integrated SSV indirect-acting	
Regulator R 70-20/2 with pneumatic 1:2 follow-up setpoint converter	19
Gas pressure regulator RSP 254 with integrated SSV direct-acting	
Regulator R 70-100	20
Types of Models / Options	21
Design	22
Properties of Gases	22
Order Data	23
Contact	25



ATTENTION

Observe the following publications in relation to installation, start-up, and maintenance: DVGW work sheets 491 and G 600 Operating and Maintenance Instructions RSP 254 / 255

List of abbreviations and formula symbols

AC	Accuracy class	$p_{ds\ o}$	Upper SSV response pressure	$W_{ds\ o}$	Upper spring adjustment range (SSV)
AG_o	Upper response pressure group	$p_{ds\ u}$	Lower SSV response pressure	$W_{ds\ u}$	Lower spring adjustment range (SSV)
AG_u	Lower response pressure group	$p_{f,max}$	Maximum closing pressure	Δp	Pressure difference from inlet pressure to outlet pressure
BV	Breather valve	PS	Maximum allowable pressure	Δp_{wo}	Min. re-engagement difference between upper response pressure and normal operating pressure
GPR	Gas pressure regulator	p_u	Inlet pressure	Δp_{wu}	Min. re-engagement difference between lower response pressure and normal operating pressure
HDS	High-pressure spindle	Q_n	Standard volumetric flow rate	ρ_n	Gas density
K_G	Valve flow rate coefficient	RE	Diaphragm assembly		
p	Pressure	RSD2	Throttle valve		
p_d	Outlet pressure	SSV	Safety shut-off valve		
p_{df}	SRV closing pressure	SRV	Safety relief valve		
p_{do}	SRV opening pressure	SG	Closing pressure group		
p_{ds}	Setpoint of the response pressure	t_{gas}	Gas inlet temperature		
		VS	Valve seat		
		w_d	Outlet gas velocity		
		w_u	Inlet gas velocity		

*) K_G value for natural gas

Application, Characteristics, Technical Data

Application

Gas pressure regulator (GDR), indirect-acting (operating with auxiliary power), for systems acc. to DVGW - work sheet G 491 (A) and G 600 (A) (TRGI).

Can be used as an equipment component on gas consumption facilities as defined in EC Directive EU/2016/426

Can be used for the gases defined in DVGW work sheet G 260 / G 262 and neutral non-aggressive gases. (other gases on request)

Characteristics

- Regulator with double-diaphragm system
- Model according to DIN EN 334 / 14382
- Integral pressure-tight model (IS)
- Gas pressure regulator with or without integrated SSV
- Compact and maintenance-friendly modular design
- SSV functional class, optionally A ($p_{ds\ u} + p_{ds\ o}$) or B ($p_{ds\ o}$)
- Open-air model

Type of model / options (see pages 22-23)

- With fine filter FF upstream of the regulator
- With pneumatic follow-up setpoint from I/P converter
- With built-in noise reduction
- Optionally with AV breather valve
- With SSV manual release
- With electric position indicator SSV "Closed" via inductive proximity initiator or via Reed contact
- With SSV electromagnetic remote release when power is applied or in case of power failure
- Oxygen model ($p_u \leq 10$ bar)
- Hydrogen model
- Coating with epoxy resin in RAL colors

Accuracy class AC / Closing pressure group SG

Accuracy class AC and closing pressure group SG at the outlet pressure range p_d	Ø Setting device		
	R70-10	R70-20	R70-100
10 mbar to 20 mbar			10 / 50
20 mbar to 50 mbar			5 / 20
50 mbar to 500 mbar	5 / 10	5 / 10	5 / 10
0.5 bar to 2.5 bar	2.5 / 10	2.5 / 10	
2.5 bar to 5 bar	1 / 10	1 / 10	
> 5 bar	1 / 5	1 / 5	

($\Delta p_{u, max} \pm 2bar$)

Response pressure group AG

Upper response pressure group AG SSV direct-acting	
30 mbar to 100 mbar	AG 10
100 mbar to 500 mbar	AG 5
> 500 mbar	AG 2.5
Lower response pressure AG	
5 mbar to 30 mbar	AG 20
30 mbar to 50 mbar	AG 10
> 50 mbar	AG 5

Technical data

Gas pressure regulator	RSP 254 / RSP 255 (with integrated SSV) RP 254 / RP 255 (without integrated SSV)
Actuator model	AS 254 / AS 255 (with integrated SSV) A 254 / A 255 (without integrated SSV)
Safety shut-off valve (SAV)	with MD control device (W_{dsu} 0 mbar - 70 mbar ; W_{dso} 35 mbar - 3000 mbar) with MD-R control device (W_{dsu} 24 mbar - 250 mbar ; W_{dso} 100 mbar - 3500 mbar) with HD control device (W_{dsu} 20 mbar - 940 mbar ; W_{dso} 2,200 mbar - 16,000 mbar)
Regulator models	R 70-10, R 70-20, R 70-20 (1:2), R 70-100
Required pressure difference for master regulator	500 mbar
Model	Integral pressure-tight (IS)
Max. allowable pressure PS	16 bar
Nominal width	RSP 254: DN 25, DN 50, DN 80, DN 100, DN 150, DN 200 RSP 255: DN 50, DN 80, DN 100
Actuator flange connection	DIN EN 1092 - flanges PN 16 ASME - B16.5 flanges Class 150 RF
Pipe connection type	G 1/4" or G 3/8" for threaded pipe connections to DIN EN ISO 8434-1 (DIN 2353)
Actuator material	Al cast alloy
Corrosivity category C1 to C5-I C5-M	DIN EN ISO 12944-2 without additional coatings an epoxy resin coating is recommended (see page23)
Regulator material	Al wrought alloy
Temperature range (operating/ambient temperature)	-20 °C to +60 °C
Function, strength, and tightness	DIN EN 334 and DIN EN 14382
Ex protection	The mechanical components of the device do not have any ignition sources of their own and are thus not covered by the scope of ATEX (2014/34/EU). Electrical components used at the device fulfil the ATEX requirements.



Design and function of the gas pressure regulator (GPR)

The gas pressure regulator RSP 254/255 has the function of keeping the outlet pressure of a regulation section downstream of a gas pressure regulator constant within specified limits, independently of changes in the gas tap or inlet pressure. The required auxiliary energy is obtained from the pressure gradient between the inlet pressure and outlet pressure of the gas pressure regulator. No external energy is required.

The GPR consists of a regulator with regulating unit, optionally with connected upstream fine filter and bypass valve, and an actuator. The control variable - the outlet pressure - is detected by a sensitive diaphragm in the regulating unit, which is part of a double-diaphragm system. The pneumatic amplifier working by the nozzle/baffle plate principle is actuated by the comparator formed by a double-diaphragm system. The bypass valve and possible changes in the setpoint spring can be used to affect the static amplification of the regulator and adjust it to the respective condition of a regulation section.

The outlet pressure is applied to the top side of the double diaphragm system in the regulating unit via a measurement line and converted into a pressure force which is compared with the set setpoint spring force that is used as defined command variable for the outlet pressure to be regulated. Any deviation from the control value is followed by a suitable proportional change in the spacing between nozzle and baffle plate, corresponding to a proportional change in the setting pressure. The valve opening required in each case for adjusting the outlet pressure actual value to the setpoint is effected by the setting pressure generated by the actuating drive of the actuator.

In the operating state, the inlet pressure taken at the inlet flows as auxiliary energy through the nozzle/baffle plate system and the bypass valve into the outlet pressure chamber, generating, depending on the position of the nozzle/baffle plate system, the setting pressure for the valve opening position required in each case against the bypass valve. The auxiliary energy gas then flows back to the outlet pressure network via the bypass valve.

In case of zero tap of the regulation section, the amplifier valve in the double-diaphragm system of the regulating unit will close tight, causing the closing pressure to be established.

Models with pneumatic follow-up setpoint inputs with 1:1 and 1:2 pressure conversions are available. Using an IP converter allows you to continuously set directly the required outlet pressure setpoint via, for example, a 4 to 20 mA signal. Moreover, by means of a setting spring, variable zero points can be suppressed.

Design and function of the safety shut-off valve (SSV) direct-acting

In case of inadmissible overpressure or lack of gas in the regulation section, the actuator of the safety shut-off valve arranged in the same housing on the inlet side will shut off the gas flow.

To this end, the outlet pressure to be monitored is passed on to the SSV control device via a separate measurement line. As a function of the change in pressure, the SSV diaphragm in the control device is raised or lowered. When the outlet pressure in the regulation section exceeds or falls below a certain response pressure, the switch socket connected to the SSV diaphragm will move to the corresponding disengaging position, the balls of the engaging mechanism will release the SSV screw spindle, and the closing spring will press the SSV valve plate against the valve seat. The SSV actuator shuts off the gas flow gas-tight.

The SSV can only be opened by hand and engaged in the open position. To do so, the outlet pressure at the measuring point must be lowered below the upper response pressure or raised above the lower response pressure by at least the re-engaging differential amount (Δp).

The SSV can, except where otherwise stipulated in specific national legislation, be used in either functional class A (with diaphragm rupture protection) or B (without diaphragm rupture protection).

There is also the option of using a remote display for the SSV position "CLOSED" and a manual and remote release when power is applied or in case of power failure.

Preferred installation position

The gas pressure regulators RSP 254 / 255 shall be installed in the pipeline preferably in horizontal position. For all nominal widths, the direction of flow is indicated by an arrow on the housing.

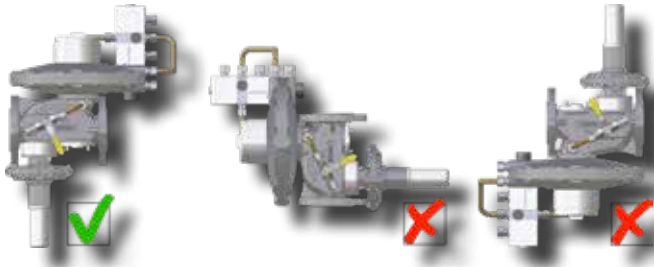

Only after consultation with
Medenus GmbH

Note: Observe the following documents in relation to installation, start-up, and maintenance:

- DVGW - work sheets G 491 and G 600
- Operating and Maintenance Instructions RSP 254 / 255

Installation examples

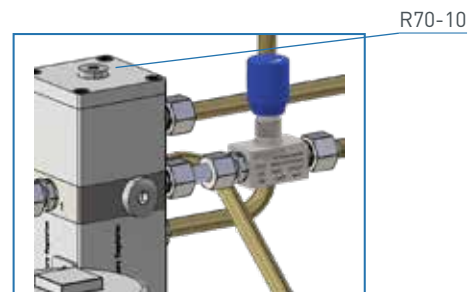
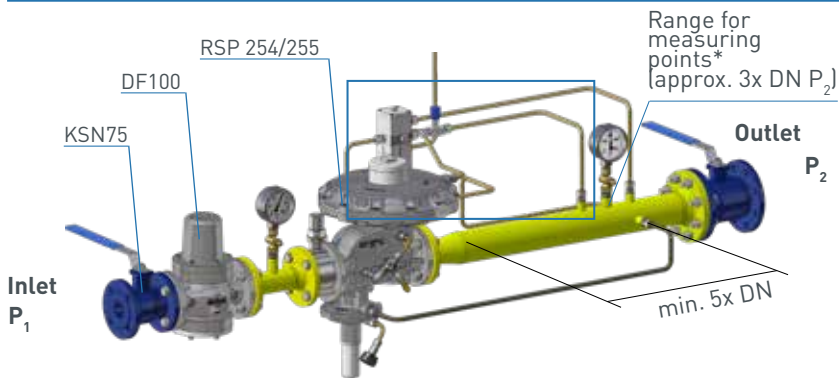

RSP 255 shown with actuator AS 255
incl. switching device MD, MD-R, or HD
and regulator R 70-10

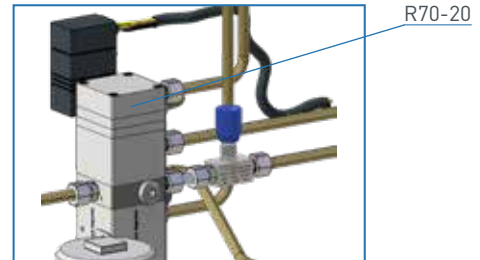
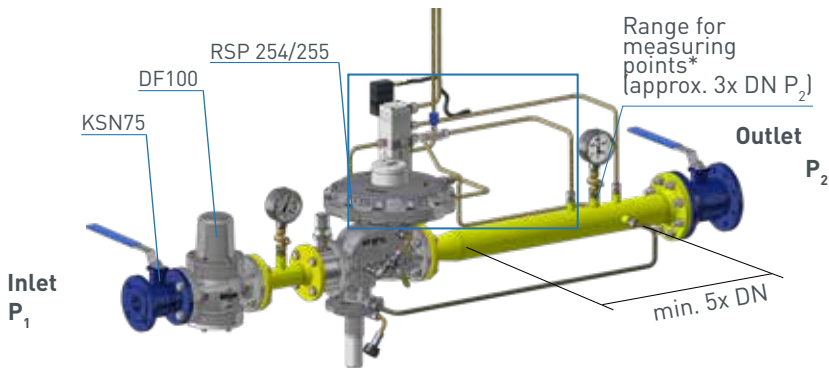

RSP 255 shown with actuator AS 255
incl. switching device MD, MD-R, or HD
and regulator R 70-10, regulator R 70-20/2,
I/P converter

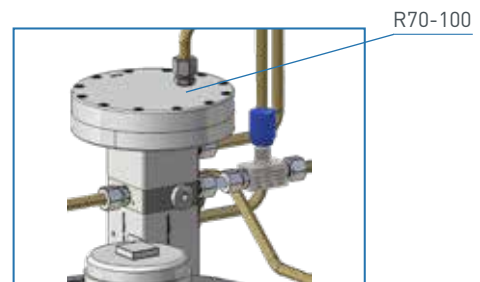
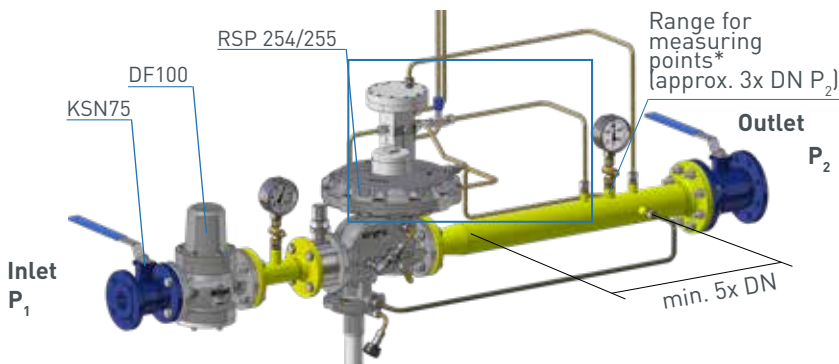

RSP 255 shown with actuator AS 255 incl. control
device MD or MD-R and regulator R 70-100

*) Recommended max. velocity at the measurement line port 25 m/s

Sectional view
Actuator AS 255

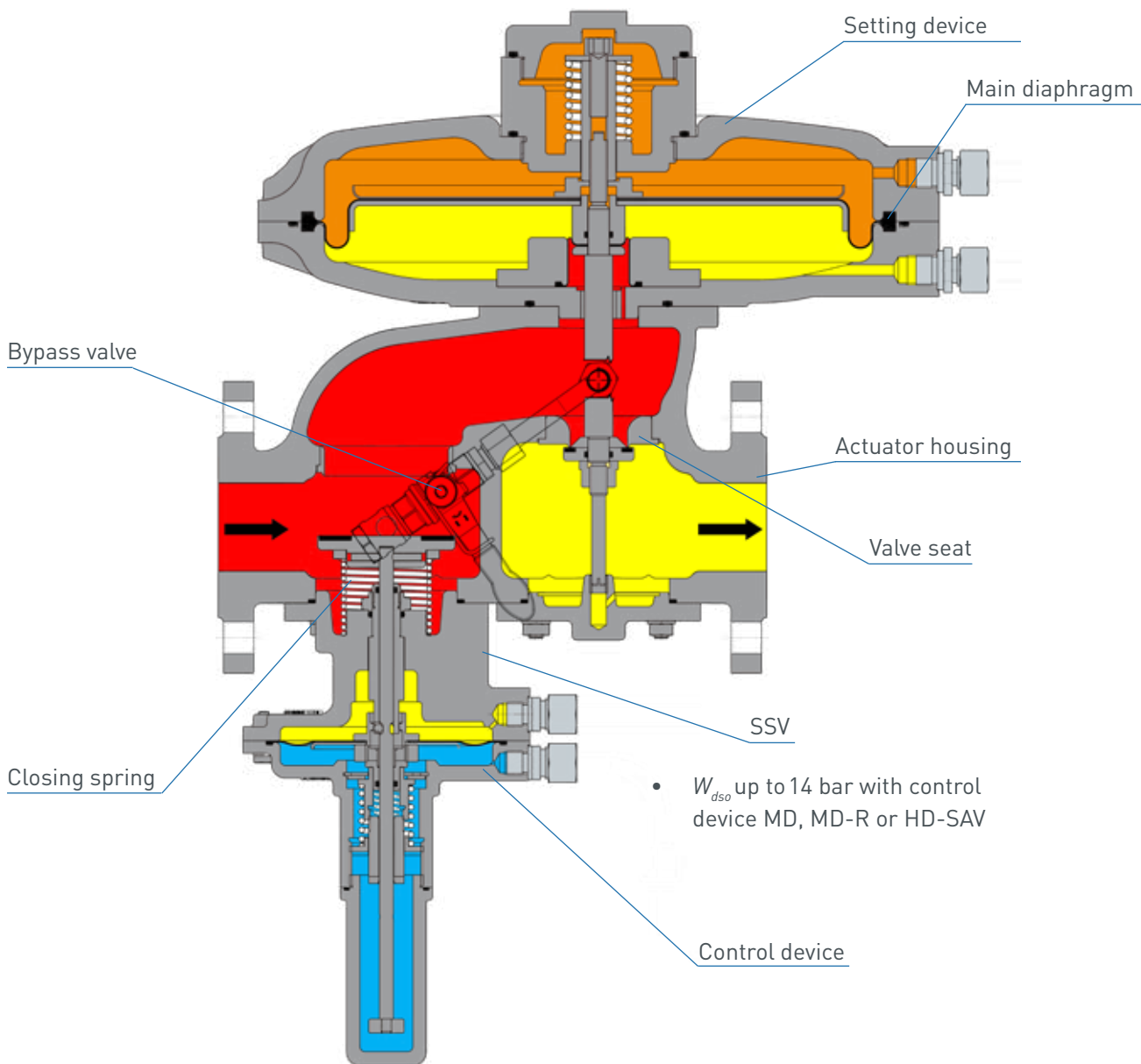

**Sectional view
Regulator R 70-10, R 70-20, R 70-100**

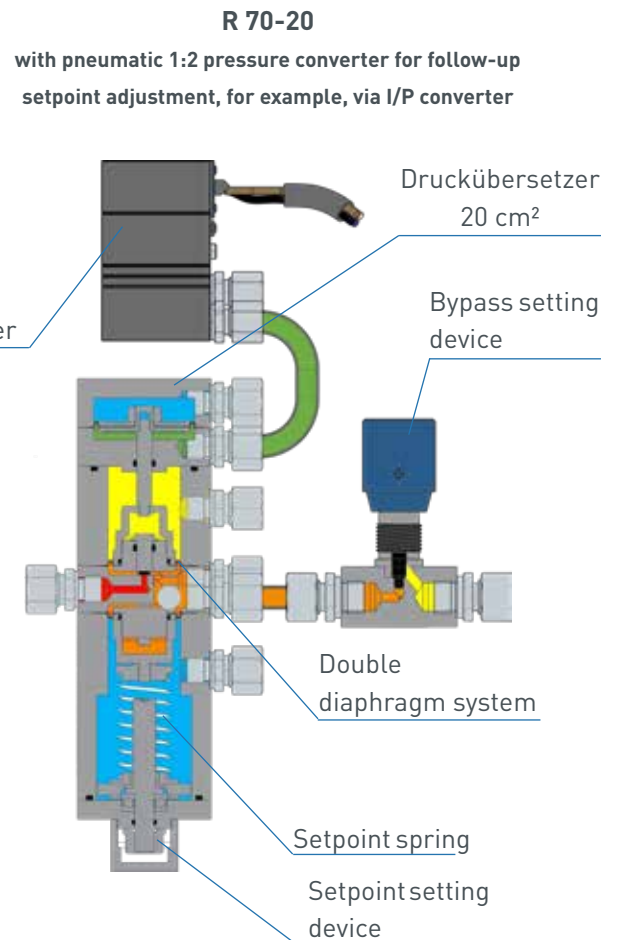
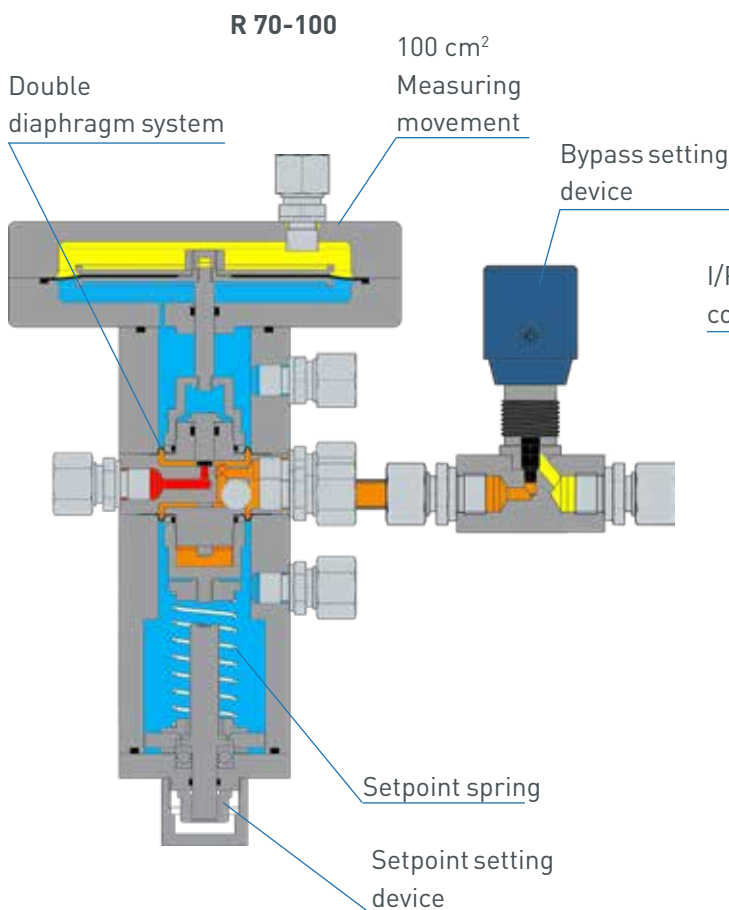
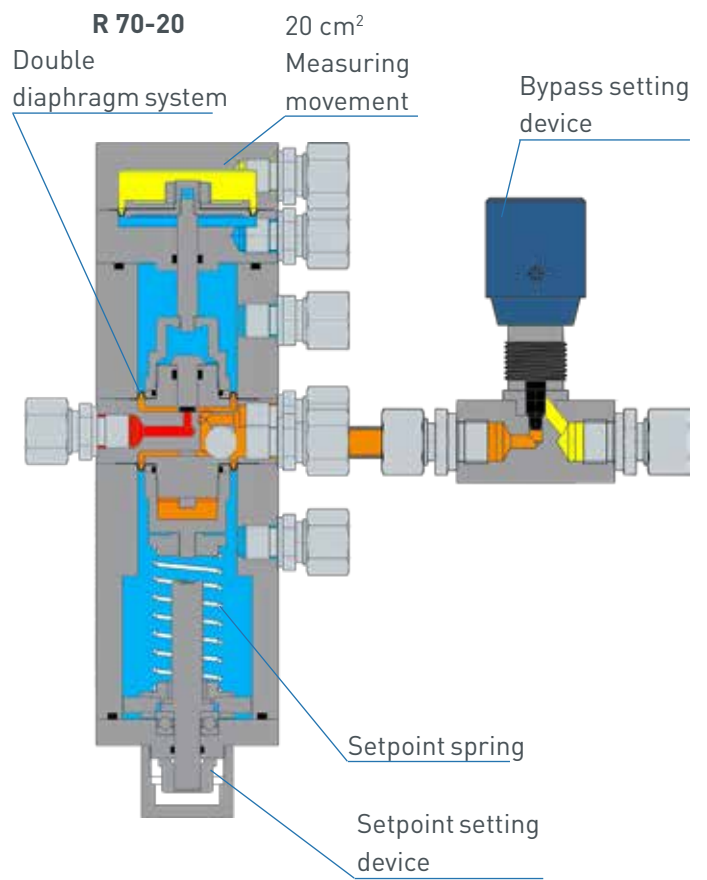
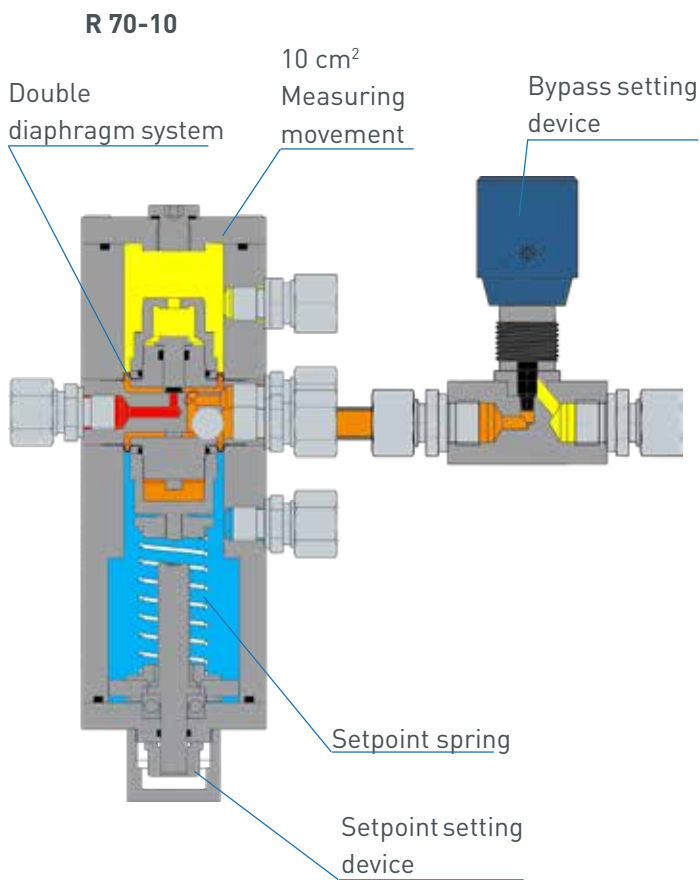

K_G value and diaphragm assemblies

(KG value for natural gas: $d = 0.64$ ($\rho_n = 0.83 \text{ kg/m}^3$), $t_u = 15^\circ \text{ C}$)

	RSP 254						RSP 255		
	DN 25	DN 50	DN 80	DN 100	DN 150	DN 200	DN 50	DN 80	DN 100
Nominal width	25	50	80	100	150	200	50	80	100
Diaphragm assembly \emptyset	330	330	390	390	385	385	390	385	385
Valve seat \emptyset									
17.5 mm	200	220							
27.5 mm	420	500	550	600			550		
32.5 mm		750	850	900			750	750	
42.5 mm			1,450	1,500	1,600		1,250	1,500	1,500
52.5 mm				1,800	2,000		1,700	1,800	1,850
65.0 mm					3,500			2,600	3,200
85.0 mm					4,600			3,500	4,300
95.0 mm					5,800	6,100			4,800
115.0 mm						8,950			
Connection type	DIN EN 1092 - PN16 ASME B 16.5 - Class 150								

Setting device is approved for a max. pressure differential of 0.5 bar.

SSV setpoint spring table - Control device direct-acting

RSP 254: DN 25 - 100 / RSP 255: DN 50 - 80									
small ball lock									
ND					MD				
to $W_{ds\ o}$ 200mbar					to $W_{ds\ o}$ 300mbar				
Spring data		Lower response pressure		Upper response pressure		Lower response pressure		Upper response pressure	
Feder Nr.	Farbe [RAL]	$W_{ds\ u}$ [mbar]	Δp_{wu} [mbar]	$W_{ds\ o}$ [mbar]	Δp_{wo}^{**} [mbar]	$W_{ds\ u}$ [mbar]	Δp_{wu} [mbar]	$W_{ds\ o}$ [mbar]	Δp_{wo}^{**} [mbar]
FE 900	1028								
FE 901 VA	2002								
FE 902 VA	6010	3 - 7	15			0 - 12*	40		
FE 903	5015	5 - 9	15			4 - 14	40		
FE 904 VA	9005	7 - 13	15			8 - 18	40		
FE 905 VA	9010	13 - 25	15			18 - 42	40		
FE 906	4002					48 - 70	40		
FD 910	1028							35 - 45	40
FD 911	2002			25 - 33	15			45 - 80	40
FD 912	6010			33 - 56	15			70 - 120	40
FD 913	5015			54 - 85	15			100 - 170	40
FD 914	9005			85 - 119	15			140 - 230	40
FD 915	9010			100 - 176	15			210 - 300	40
FD 916	3050			152 - 200	15				
FD 917	5010								
FD 918	9006								
FD 919	4002								

SSV setpoint spring table - Control device direct-acting

RSP 254: DN 25 - 100 / RSP 255: DN 50 - 80									
small ball lock									
MD-R					HD				
to $W_{ds\ o}$ 3500mbar					to $W_{ds\ o}$ 16000mbar				
Spring data		Lower response pressure		Upper response pressure		Lower response pressure		Upper response pressure	
Feder Nr.	Farbe [RAL]	$W_{ds\ u}$ [mbar]	Δp_{wu} [mbar]	$W_{ds\ o}$ [mbar]	Δp_{wo}^{**} [mbar]	$W_{ds\ u}$ [mbar]	Δp_{wu} [mbar]	$W_{ds\ o}$ [mbar]	Δp_{wo}^{**} [mbar]
FE 900	1028								
FE 901 VA	2002					20 - 120*	500		
FE 902 VA	6010	24 - 74	90			120 - 310*	500		
FE 903	5015	36 - 78	90			160 - 316	500		
FE 904 VA	9005	58 - 110	90			200 - 400	500		
FE 905 VA	9010	110 - 160	90			416 - 650	500		
FE 906	4002	162 - 250	90			560 - 940	500		
FD 910	1028			100 - 135	50				
FD 911	2002			130 - 250	50				
FD 912	6010			220 - 360	50				
FD 913	5015			320 - 510	50				
FD 914	9005			440 - 700	50				
FD 915	9010			630 - 1130	50			2200 - 4000	300
FD 916	3030			1060 - 1750	50			3400 - 4750	300
FD 917	5010			1420 - 2520	50			4700 - 7400	300
FD 918	9006			1850 - 3200	50			7200 - 12100	300
FD 919	4002			2800 - 3500	50			11700 - 16000	300

RSP 254: DN 150 - 200 / RSP 255: DN 100									
large ball lock									
ND					MD				
to $W_{ds\ o}$ 200mbar					to $W_{ds\ o}$ 300mbar				
Spring data		Lower response pressure		Upper response pressure		Lower response pressure		Upper response pressure	
Feder Nr.	Farbe [RAL]	$W_{ds\ u}$ [mbar]	Δp_{wu} [mbar]	$W_{ds\ o}$ [mbar]	Δp_{wo} [mbar]	$W_{ds\ u}$ [mbar]	Δp_{wu} [mbar]	$W_{ds\ o}$ [mbar]	Δp_{wo} [mbar]
FM 400	1028	3 - 25	20			10 - 40*	30		
FM 402	6010					35 - 115	30		
FM 404	9005					60 - 245	30		
FL 411	2002			45 - 81	20				
FL 412	6010			62 - 111	20			40 - 180	50
FL 413	5015			100 - 200	20			70 - 300	50
FL 415	9010								
FL 417	4010								

RSP 254: DN 150 - 200 / RSP 255: DN 100									
large ball lock									
MD-R					HD				
bis $W_{ds\ o}$ 3500mbar					bis $W_{ds\ o}$ 16000mbar				
Spring data		Lower response pressure		Upper response pressure		Lower response pressure		Upper response pressure	
Feder Nr.	Farbe [RAL]	$W_{ds\ u}$ [mbar]	Δp_{wu} [mbar]	$W_{ds\ o}$ [mbar]	Δp_{wo} [mbar]	$W_{ds\ u}$ [mbar]	Δp_{wu} [mbar]	$W_{ds\ o}$ [mbar]	Δp_{wo} [mbar]
FM 400	1028	20 - 180*	60			0 - 250	500		
FM 402	6010	155 - 380	60			150 - 1000*	500		
FM 404	9005	200 - 950	90			650 - 2050	500		
FL 411	3002								
FL 412	6010			145 - 670	180			380 - 1400	500
FL 413	5015			270 - 1230	180			800 - 2800	500
FL 415	9010			1200 - 3500	180			3200 - 5500	500
FL 417	4010							4500 - 16000	500

Determining the upper response pressure

Output pressure P_d	Upper response pressure $W_{ds\ o}$ *
≤ 200 mbar	$P_d + 100$ mbar
> 200 mbar to ≤ 800 mbar	$P_d \times 1.5$
> 800 mbar to $\leq 1,600$ mbar	$P_d \times 1.3$
$> 1,600$ mbar	$P_d + 500$ mbar
$> 3,000$ mbar	$P_d + 1000$ mbar

*) Standard spring

**)

If the control device is set up simultaneously for the upper and lower set pressure (functional class A) the difference between the setpoints of the upper and lower response pressure ($p_{ds\ o}$ and $p_{ds\ u}$) and the outlet pressure p_d must be at least " $\Delta p_{wo} + 10\%$ " or " $\Delta p_{wu} + 10\%$ ". Otherwise it cannot be guaranteed that the control device will re-engage.

Regulator setpoint spring table

R70-100	R70-20		R70-10		Spring data	
P_{d100} [mbar]	P_{d20} [mbar]	P_{d20s} [mbar] (1:2)	P_{d10} [mbar]	P_{d10s} [mbar] (1:1)	Spring no.	Color [RAL]
0-37	0-180	$P_{d20s} = P_{d10} + Ph * 2$		$P_{d10s} = P_{d10} + P_h$	FD 911	3002
30-85	150-400		300-850		FD 912	6010
55-160	250-750		550-1600		FD 913	5015
100-260	550-1250		1000-2600		FD 914	9005
200-460	1000-2250		2000-4600		FD 915	9010
400-500	2000-3000		4000-6200		FD 917	5010
	3000-6500		6000-13000		FD 918	9006

Ph Pressure of the auxiliary pressure stage of the follow-up setpoint (0-6 bar)

P_{d100} Outlet pressure R70-100

P_{d20} Outlet pressure R70-20

P_{d20s} Outlet pressure R70-10 with 1:2 follow-up setpoint adjustment

P_{d10} Outlet pressure R70-10

P_{d10s} Outlet pressure R70-10 with 1:1 follow-up setpoint adjustment

*) The upper response pressure is rounded up to full tens, for example 251 mbar -> 260 mbar

Dimensions, Connection, and Weight

Dimensional drawing of gas pressure regulator

Gas pressure regulator
RSP 255 consisting of:

Actuator AS 255
Regulator R 70-10

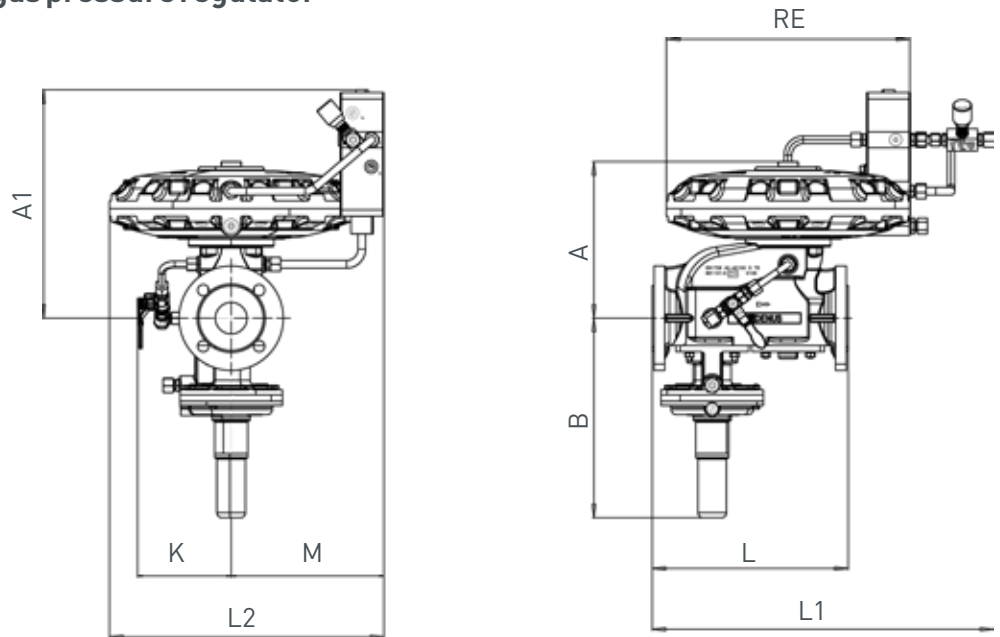

Gas pressure regulator
RSP 255 consisting of:

Actuator AS 255
Regulator R 70-20/2
with I/P converter

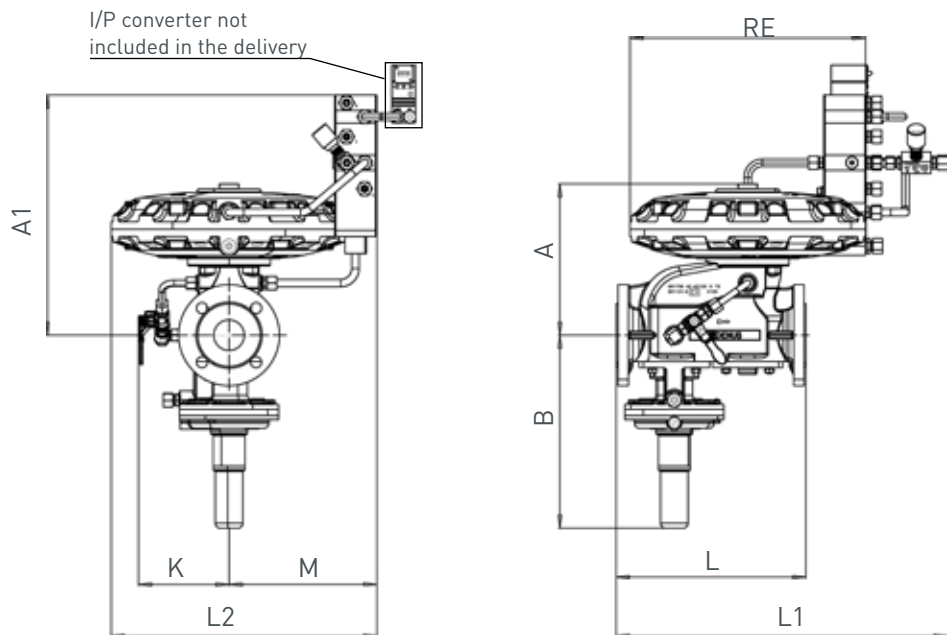

Gas pressure regulator
RSP 255 consisting of:

Actuator AS 255
Regulator R 70-100

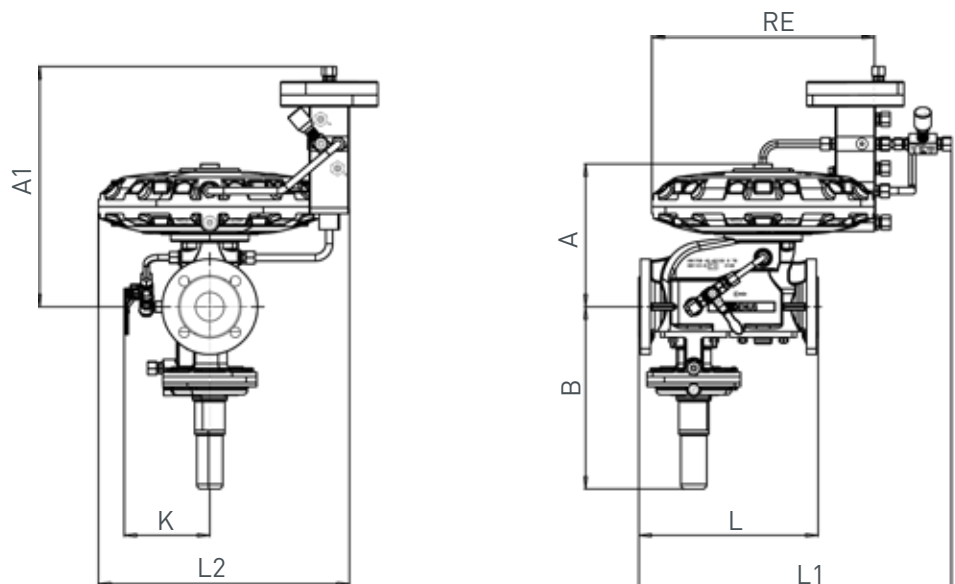

Dimensional drawing of regulator

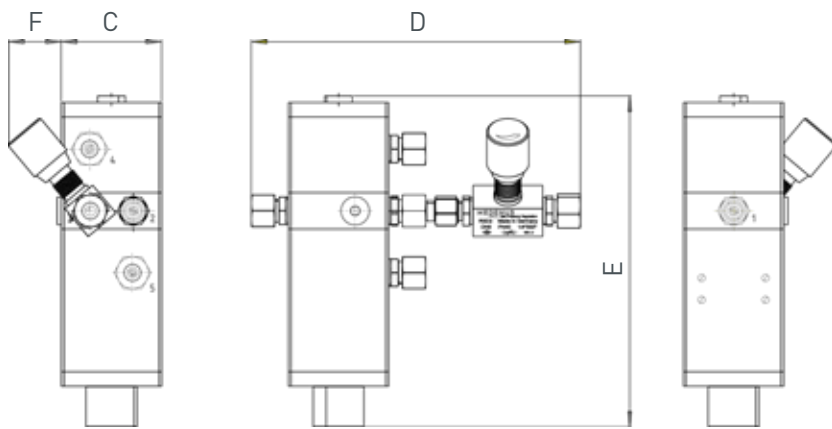

Pressure range: 0.5 bar - 12 bar



R 70-10

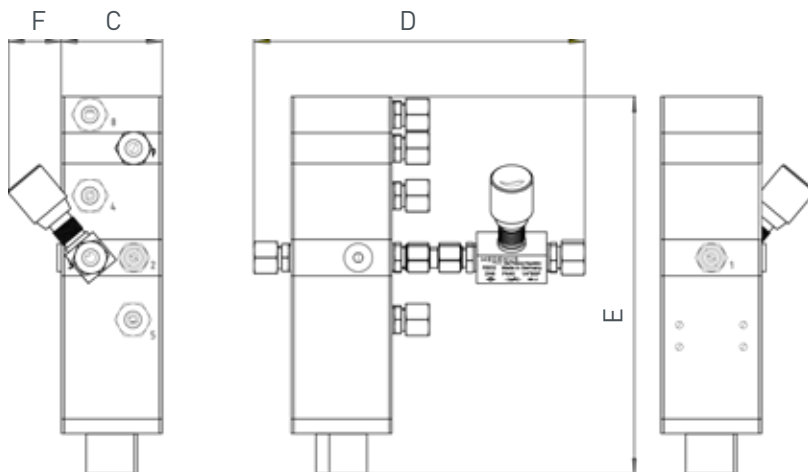

Pressure range: 0.1 bar - 6 bar



R 70-20

R 70-20/2 with follow-up setpoint adjustment (1:2)

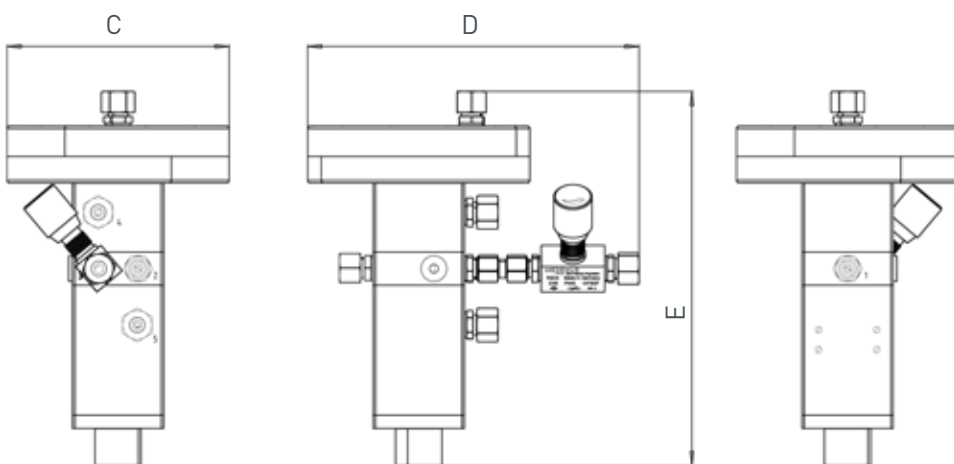

Pressure range: 10 bar - 500 mbar



R 70-100

Dimensions and weight

Gas Pressure Regulator		RSP 254						RSP 255		
Dimensions	Nominal width	DN 25	DN 50	DN 80	DN 100	DN 150	DN 200	DN 50	DN 80	DN 100
	A [mm]	RE 330	214	232	-	-	-	-	-	-
	RE 385/390	-	-	293	308	370	510	292	370	441
A1* [mm]	R 70-10	280	300	361	375	493	561	361	421	493
	R 70-20	312	332	392	406	525	593	392	453	525
	R 70-100	337	357	417	431	550	618	418	478	549
B [mm]		270	282	305	315	386	400	305	311	386
B [mm] model with HD SSV		+10	+10	+10	+10	+23	+23	+10	+10	+23
M [mm]		221	221	242	242	242	242	242	242	242
L [mm]		230	230	310	350	480	600	310	410	480
K [mm]		144	144	160	171	199	228,5	160	176	199
L1* [mm]		452	452	541	583	666	756	541	616	666
L2* [mm]	R 70-10									
	R 70-20	387	387	435	435	435	435	435	435	435
	R 70-100									
Y [mm]		100	100	100	100	150	150	100	150	150
Weight [kg]	RE 330	13,5	15	-	-	-	-	22	-	-
	RE 385/390	-	-	28	29	58	88	-	42	58
Actuator connection	DIN EN 1092 - PN16									
	ASME B 16.5 - Class 150									

Regulator	R 70-10	R 70-20	R 70-100
C [mm]	69	69	∅ 168
D [mm]	228	228	251
E [mm]	228	259	284
F [mm]	36,5	36,5	
Weight [kg]	3,7	4,2	5,3
Regulator connection	G 1/4		

Reactivation of SSV



*) The dimensions depend on the lengths of the piping and may vary!

AS 254: Connection of the functional line and breather line

Nominal width	Setting device Setting pressure line / Return line	SSV control device direct-acting	
		SSV measurement line	Breather line
DN 025	Connection* for: Tube 12 x 1.5 (thread G 3/8)	Connection* for: tube 12 x 1.5 (thread G 1/4)	
DN 050			
DN 080		Connection* for: tube 12 x 1.5 (thread G 3/8)	
DN 100			
DN 150			
DN 200			

AS 255: Connection of the functional line and breather lines

Nominal width	Setting device Setting pressure line / Return line	SSV control device direct-acting	
		SSV measurement line	Breather line
DN 050	Connection* for: Tube 12 x 1.5 (thread G 3/8)	Connection* for: tube 12 x 1.5 (thread G 1/4)	
DN 080		Connection* for: tube 12 x 1.5 (thread G 3/8)	
DN 100			

R 70: Connection of the functional line and breather lines

	Function / Breather line
R 70-10	Connection* for: Tube 12 x 1.5 (thread G 1/4)
R 70-20 (1:2)	
R 70-100	

Note: Observe the following documents in relation to installation, start-up, and maintenance:

DVGW - work sheets G 491 and G 600

Operating and Maintenance Instructions RSP 254 / 255

The gas pressure regulators RSP 254 / 255 shall be installed in the pipeline preferably in horizontal position. For all nominal widths, the direction of flow is indicated by an arrow on the housing.

*) Threaded pipe connections to DIN EN ISO 8434-1 (DIN 2353)

Connection example

Connections R70

Connection no.	R70-10		R70-20	R70-100	
1	Inlet pressure line		Inlet pressure line	Inlet pressure line	
2	Setting pressure line		Setting pressure line	Setting pressure line	
3	Bypass line		Bypass line	Bypass line	
4	Measurement line		Measurement line	Breather line	
5	Breather line	Pneumatic follow-up setpoint (I/P converter)	Breather line	Breather line	Pneumatic follow-up setpoint (I/P converter)
6				Measurement line	
7			Pneumatic follow-up setpoint (I/P converter)		
8			Breather line		
9					
10					
11					
12					

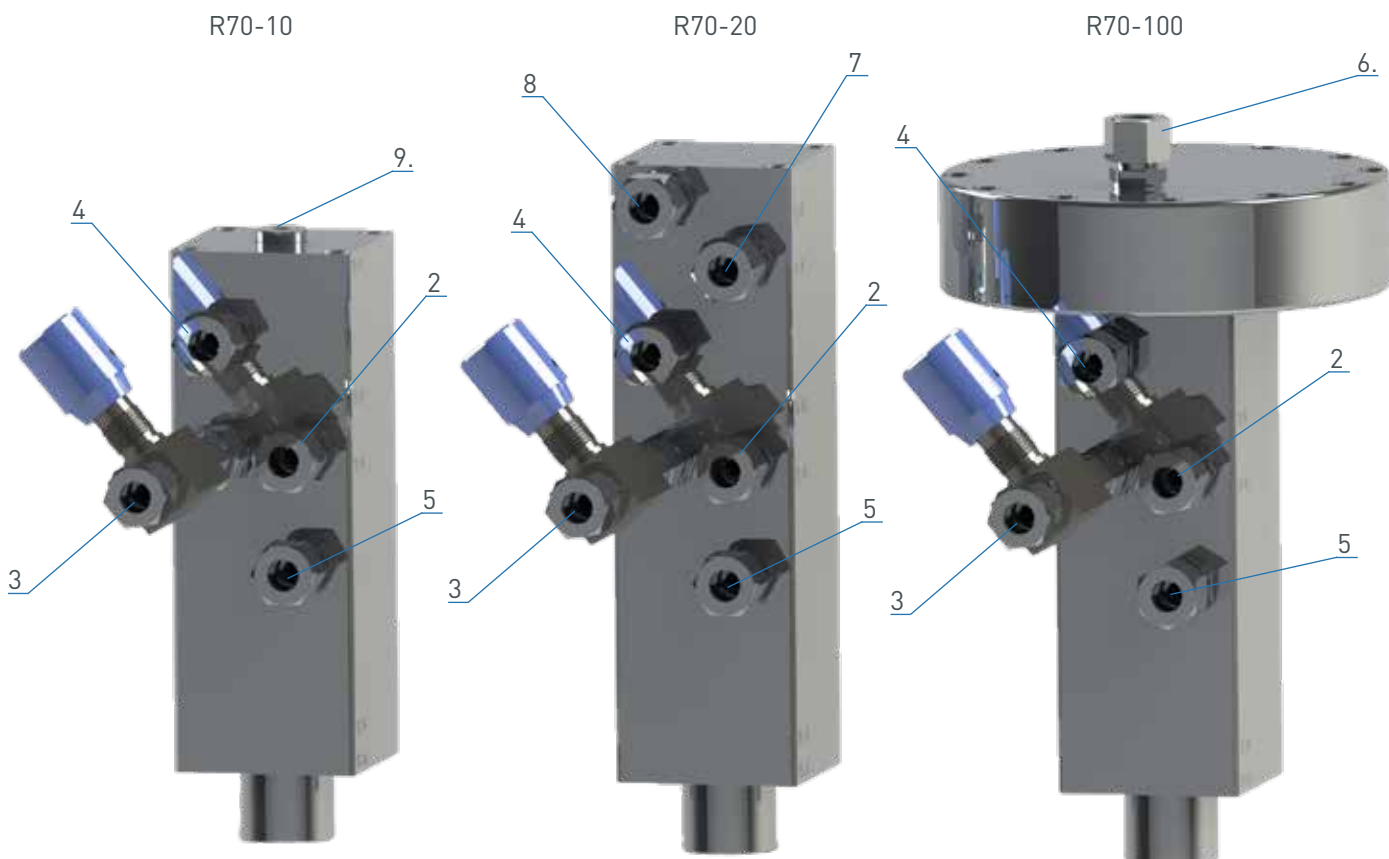

**Gas pressure regulator RSP 254
with integrated SSV direct-acting
(optionally with pneumatic follow-up setpoint
I/P converter)**



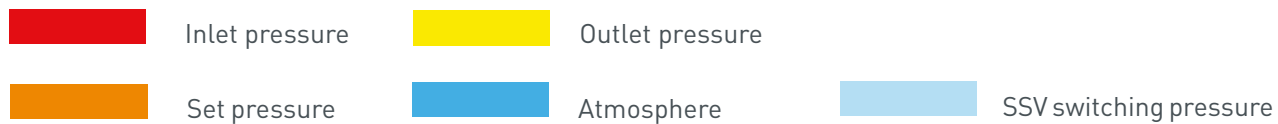
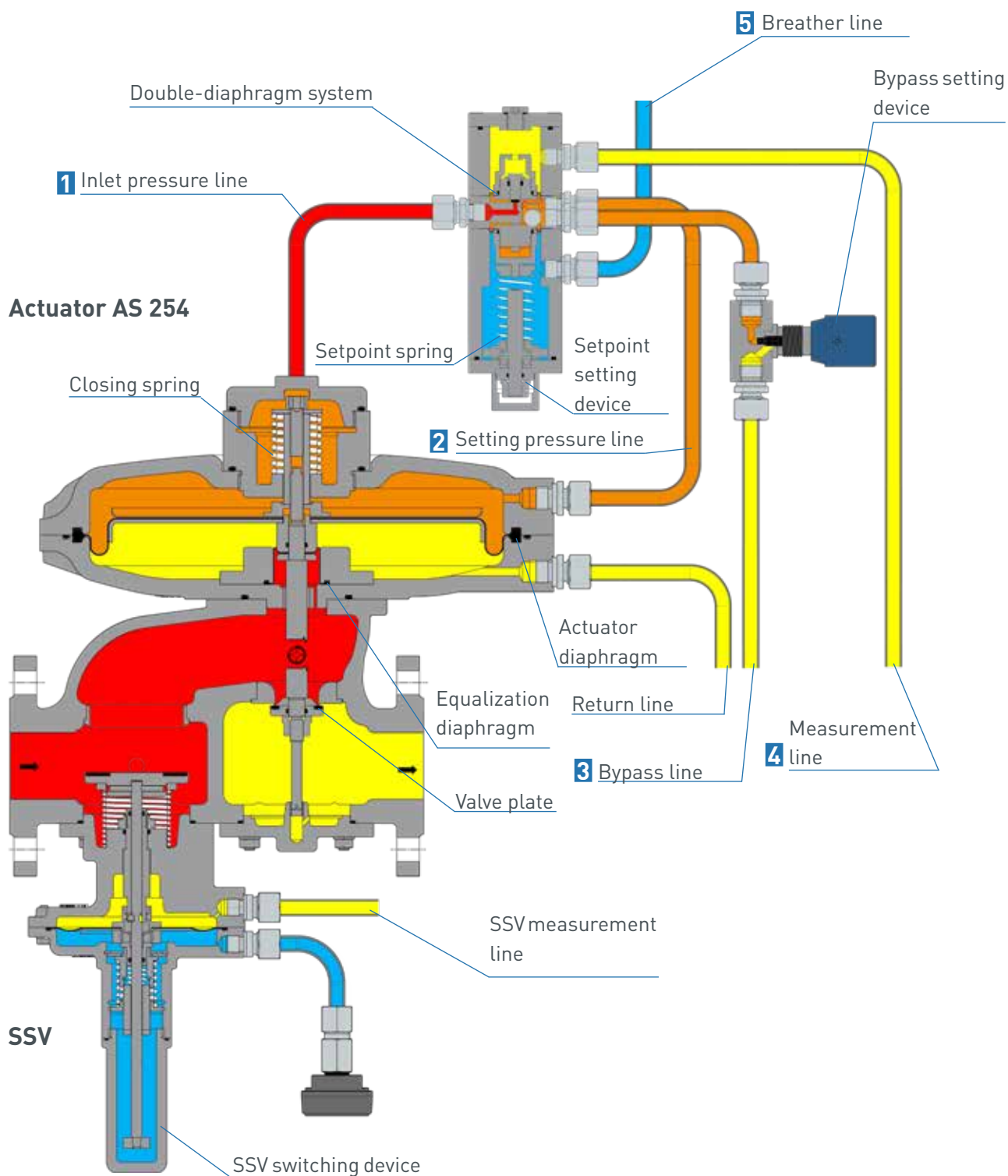



Regulator R 70-10

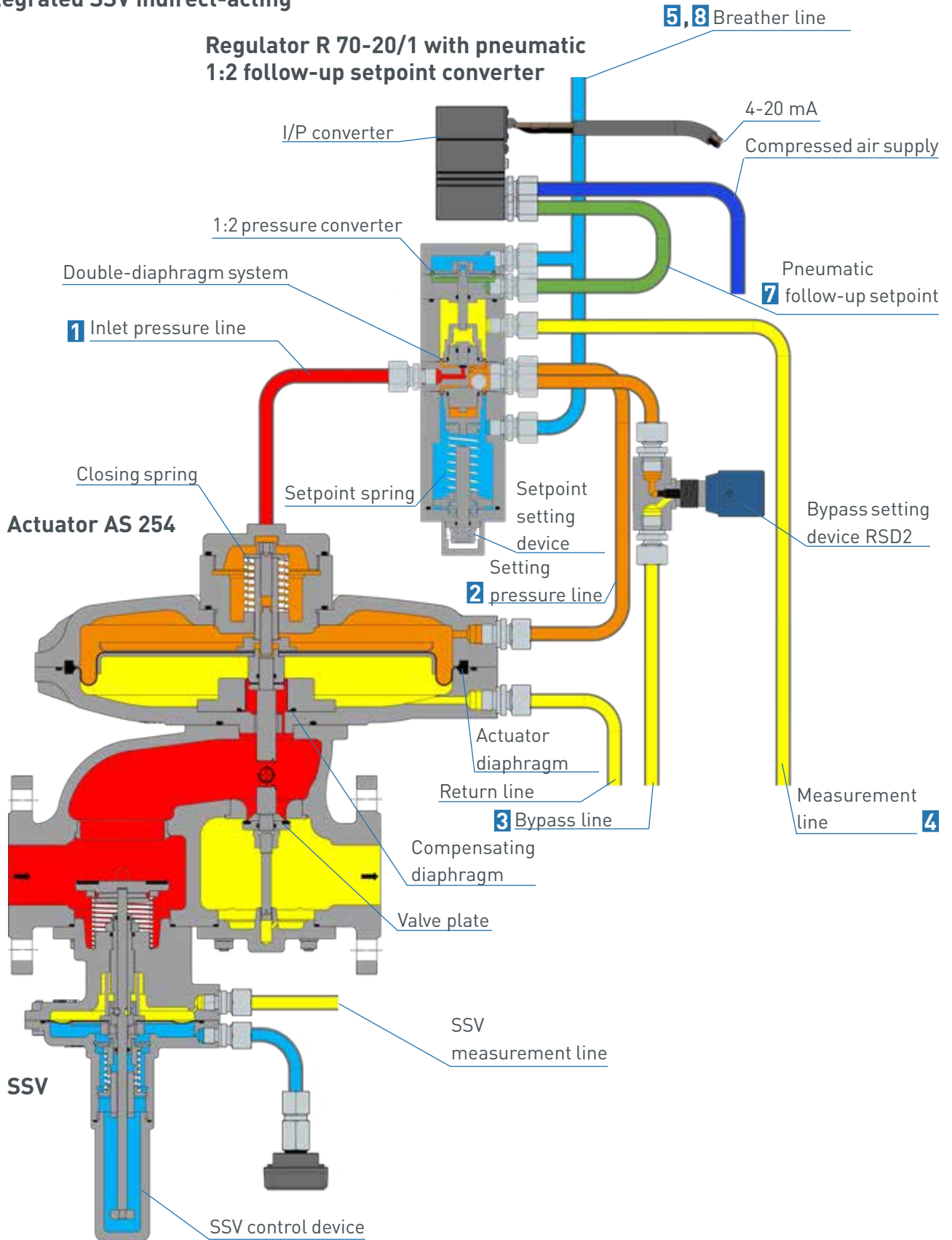

Design of the gas pressure regulator RSP

Gas pressure regulator RSP 254 with integrated SSV indirect-acting



	Inlet pressure		Outlet pressure		Follow-up setpoint
	Set pressure		Atmosphere		SSV switching pressure

**Gas pressure regulator RSP 254
with integrated SSV direct-acting
(optionally with pneumatic follow-up setpoint
I/P converter)**

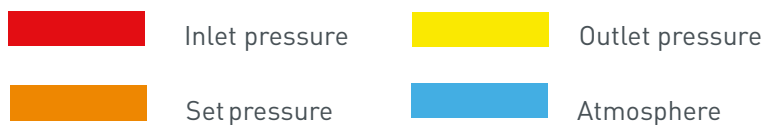
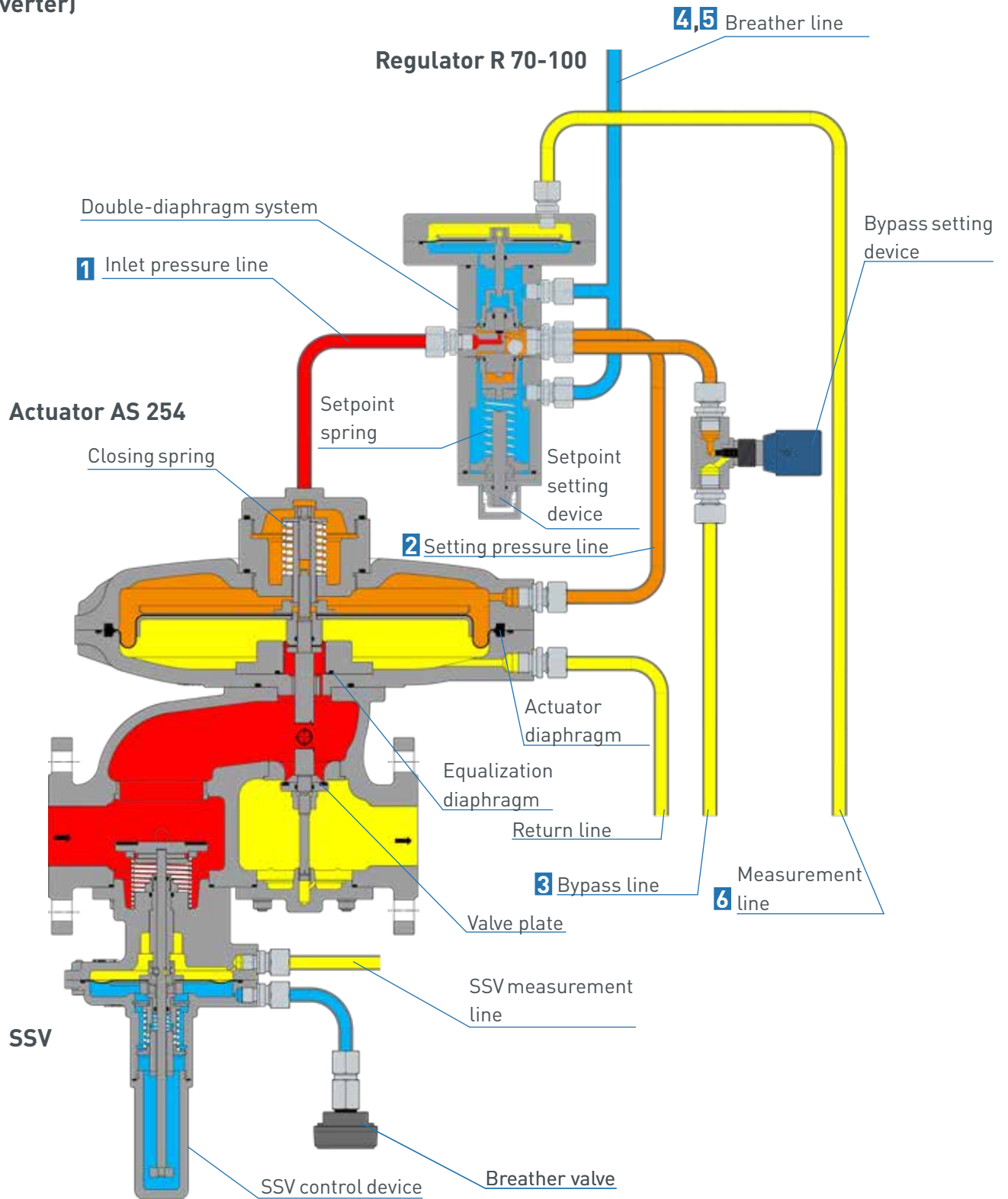

Types of models / Options

Fine filter FF

Fine filters FF are intended to separate gas impurities such as dust, rust, and other solids in gas-carrying lines at a defined point. They are used in the inlet pressure line between the actuator RSP and the regulator R70. Fine filters FF can be used for gases according to DVGW worksheet G 260/G 262 and for neutral non-aggressive gases. (other gases on request)



Noise reduction

The noise reduction made of metallic foam reduces noise in the gas pressure regulator produced by the flow rate by up to -15 dB (± 3 dB).

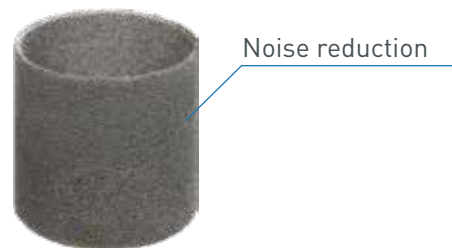

AV breather valve

The AV breather valve is used to secure the installation room against inadmissible escape of gas from diaphragm comparator compartments of safety shut-off valves. In case of a defect, the impermissible escape of gas into the surrounding atmosphere is limited to a maximum of 30l/h (air).

It also serves as a substitute for an expensive and complex installation of breather lines.

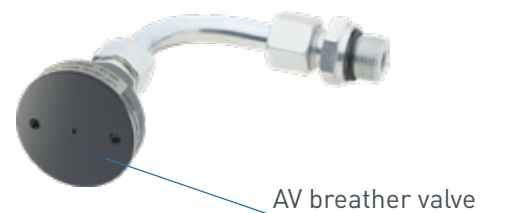

(Option not available for hydrogen version H₂)

Reed contact / inductive transmitter

Reed contacts and inductive transmitters are used to monitor the position (closed or open position) of the safety shut-off valve via remote display.



SSV manual and remote release

The direct-acting safety solenoid valve is used as electromagnetic remote release for closing the safety shut-off valve when power is applied or in case of power failure.



Epoxy resin coating in RAL colors

To protect the gas pressure regulator from external influences, starting from a corrosivity category C5-M we recommend an epoxy resin coating.



Types of models

Oxygen version O_2 ($p_u \leq 10$ bar)
 Hydrogen version H_2 (with helium leak test)

The Medenus gas pressure regulators are suitable for use with hydrogen as a medium up to a proportion of 100%.



Further information can be found in the special edition (10/2019) of gwf Gas+Energie and on our homepage at (www.medenus.de)

Design

Calculation of the required K_G value

$p_d / p_u > 0.5$
 Valve flow rate coefficient K_G at
 a subcritical pressure ratio

$$K_G = Q_n / \sqrt{p_d \cdot (p_u - p_d)}$$

$p_d / p_u \leq 0.5$
 Valve flow rate coefficient K_G at
 a supercritical pressure ratio

$$K_G = 2 \cdot Q_n / p_u$$

Note: All calculated pressures are absolute pressures.

Device selection

The device is selected on the basis of its K_G value from the table of flow rate coefficients (page 10)

Note: For the device design, a capacity reserve of 10% is recommended.

Example:

$p_{u \min}$ 5.0 bar / $p_{u \max}$ 8.0 bar
 $p_{d \min}$ 0.3 bar / $p_{d \max}$ 0.5 bar
 $Q_{n \min}$ 800 m³/h / $Q_{n \max}$ 1,500 m³/h

1.5 bar / 6 bar = 0.25 < 0.5

→ Supercritical pressure ratio
 $K_G = 2 \cdot 1500 / 6 = 500$ [m³/(h*bar)]

AS 254 DN 50 VS 32,5
 K_G value: 750 m³/(h*bar)

Properties of Gases

- for natural gas ($\rho_n = 0.83$ kg/m³; $t = 15^\circ\text{C}$)
- Δp = pressure difference from inlet pressure to outlet pressure
- Q_n = max. possible volume flow (determined using K_G values with a safety margin of 10%)
- f - natural gas conversion factor- L

Gas	f	Hs,n [kWh/m ³]	Gas	f	Hs,n [kWh/m ³]
Acetylene	0.84	16.25	Sewage gas	0.84	
Ammonia	1.04	4.83	Carbon monoxide	0.81	3.51
Butane	0.55	37.23	Carbon dioxide	0.65	-
Chlorine	0.51	-	Air	0.80	-
Landfill gas	approx. 0.80		Methane	1.08	11.06
Natural gas L	1.00	9.77	Propane	0.64	28.03
Natural gas H	1.03	11.45	Oxygen	0.76	-
Ethane	0.78	19.55	Sulphur dioxide	0.53	-
Ethylene	0.97	16.516	Nitrogen	0.81	-
Mine gas (30% CH ₄)		0.86	Hydrogen	3.04	13.43
Helium	2.15	-			

Order Data

Example:

Actuator with gas pressure regulator: RSP 254/050/390/32.5/MD-R/left/SR/BV/N/H/R 70-10/WAZ/So

		Order code:	RSP 254	050	-	390	32.5	MD-R	-	left	SR	BV	N	H	R 70-10	WAZ	So
Order selection		Designation															
Type																	
RSP 254	with integrated SSV	RSP 254	RSP 254														
RSP 255		RSP 255															
RP 254	without integrated SSV	RP 254															
RP 255		RP 255															
DN - Nominal width		Table p. 11		050													
Flange model																	
PN 16		-		-													
Class 150		C															
RE - Diaphragm assembly						390											
D - Nozzle (valve seat diameter)		Table p. 11					32,5										
SSV																	
with control device MD		MD															
with control device MD-R		MD-R						MD-R									
with control device HD		HD															
SSV functional class																	
A incl. diaphragm rupture protection		-							-								
B		B															
Direction of flow																	
Right (from left to right)		-															
Left (from right to left)		left								left							
Noise reduction		Fig. p. 22															
without noise reduction		-															
with noise reduction		SR									SR						
SSV valve accessories		Fig. p. 22															
without SSV valve accessories		-															
Breather valve		BV										BV					
Electrical position indicator, SSV "Closed"		Fig. p. 22															
without electrical position indicator		-															
with ... , via proximity switch		N											N				
with ... , via Reed contact		R															
SSV release		Fig. p. 22															
without release		-															
with manual release		H												H			
with electromagnetic remote release, when power is supplied		SG															
with electromagnetic remote release, in case of power failure		SA															
Regulator		Fig. p. 15															
R 70-10 (0.5 bar to 12 bar)		R 70-10													R 70-10		
R 70-20/2 (0.1 bar to 6 bar) + P_{dF} (1:2)		R 70-20/2															
R 70-100 (10 mbar - 500 mbar)		R 70-100															
without acceptance test certificate		-															
with acceptance test certificate		WAZ														WAZ	
Special model		So															So
- Coating with epoxy resin in RAL colors																	

Notes

A series of 28 horizontal dotted lines for taking notes.

Contact



Management
ALEXANDER CHRISTIANI

Phone: +49 (0) 2761 / 82788-18
Mail: a.christiani@medenus.de



Technical Inside Sales Department
MINDAUGAS PECKAITIS

Phone: +49 (0) 2761 / 82788-23
Mail: m.peckaitis@medenus.de



Head of Inside Sales Department
MANUEL SCHEPP

Phone: +49 (0) 2761 / 82788-20
Mobile phone: +49 (0) 170 / 6355309
Mail: m.schepp@medenus.de



Inside Sales Department
SEBASTIAN HUCKESTEIN

Phone: +49 (0) 2761 / 82788-11
Mail: s.huckestein@medenus.de



Inside Sales Department
STEFANIE MÜLLER

Phone: +49 (0) 2761 / 82788-13
Mail: s.mueller@medenus.de



If you want to know more about solutions from MEDENUS for the gas industry, please contact your local contact person or go to our internet site at www.medenus.de

Trade representation worldwide
medenus.de/de/kontakt.html

MEDENUS
Gas-Druckregeltechnik GmbH

Im Langen Feld 3
D-57462 Olpe
Phone: +49 (0)2761 82788-0
Fax: +49 (0)2761 82788-9
Mail: info@medenus.de
Internet: www.medenus.de



THE MEDENUS PLUS

10 reasons for good business relations

1. Consultancy expertise and quality standards developed over decades
2. Broad and proven standard range of feedback controllers
3. Modern, fast and efficient production for series products and for individual orders
4. Customer-specific design of pressure regulators and vacuum regulators and special designs
5. Guaranteed deadline compliance with a delivery deadline guarantee
6. Fast response time in all matters
7. Sufficiently large parts storage for production and spare parts
8. Customer-specific theory & practice training courses
9. Modular design right across the entire product range to facilitate optimized handling of spare parts
10. 100% Made in Germany

In the download area of our homepage, this document is available in different languages. You can use the following QR codes and links to go directly to this document in your language.



Deutsch:

http://medenus.de/files/upload/downloads/RSP_254/Pi_RSP_254_255_de.pdf



English:

http://medenus.de/files/upload/downloads/RSP_254/Pi_RSP_254_255_en.pdf

Notes

.....

.....

.....

.....

.....

.....

.....

.....

.....

.....

.....

.....

.....

.....

.....

.....

.....

.....

.....

.....

.....



MEDENUS Gas-Druckregeltechnik GmbH

Phone +49 (0)2761 82788-0

Fax +49 (0)2761 82788-9

Im Langen Feld 3 / D-57462 Olpe

info@medenus.de

www.medenus.de

EN